

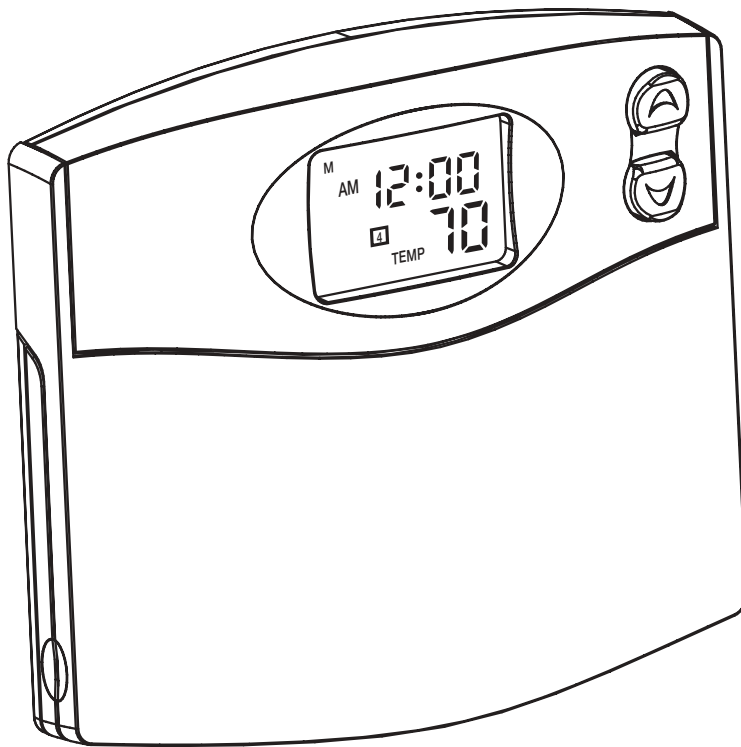

Set & Save

Programmable Thermostat



Owners Manual

Model 44110



Congratulations!

Your new Hunter thermostat will provide years of reliable service. By saving energy, your thermostat will pay for itself during its first season of use. Thank you for buying a Hunter product!

Please read this manual for complete instructions on installing and operating your thermostat. If you require further assistance, call Hunter Technical Support at 1-888-830-1326 from 8am to 5pm Central Time.

Before starting, remove the mylar label from the LCD display.

IMPORTANT INFORMATION

1. This thermostat is designed to work on the following systems:

- | | |
|---------------------------|--|
| Gas - Standing Pilot | Electric Furnace |
| Gas - Electronic Ignition | Electric Air Conditioning |
| Gas - Fired Boilers | |
| Gas - Millivolt Systems | This thermostat will NOT control single-stage or multi-stage heat pumps or 110/220 V baseboard electric heating systems. |
| Oil - Fired Boilers | |
| Oil - Fired Furnace | |

2. Temperature Range

This thermostat can be programmed between 45°F and 95°F (7°C and 35°C). It will display room temperatures from 30°F to 99°F (0°C and 37°C). "HI" will be displayed if the temperature is higher than 99°F (37°C), and "LO" will be displayed if the temperature is lower than 30°F (0°C).

This thermostat will automatically cut-off in Heat mode if the temperature rises above 95°F (35°C), and automatically cut-off in Cool mode if the temperature drops below 40°F (4°C).

3. Compressor Protection

This thermostat provides a 3.5 minute delay after shutting off the cooling system before it can be restarted. This feature will prevent damage to your compressor caused by rapid cycling. It does not prevent a rapid compressor restart due to short power outages.

4. Battery Warning

Two fresh AA alkaline batteries should provide well over one year of service. However, when the batteries become drained, the Low Battery Indicator will flash on the display. When this message occurs, install new alkaline batteries. You have approximately 1 minute to change the batteries and keep thermostat's clock and program settings. Once the batteries have become too low to ensure proper operation, your system will be turned Off, and the display will be cleared except for flashing Low Battery Indicator on the LCD display.

CAUTION: When only the battery icon flashes on the display, the thermostat is shut down, and your system will no longer operate. In this condition, there is no temperature control of your dwelling.

NOTE: If you plan to be away from the premises over 30 days, we recommend that you replace the old batteries with new alkaline batteries prior to leaving.

FEATURES

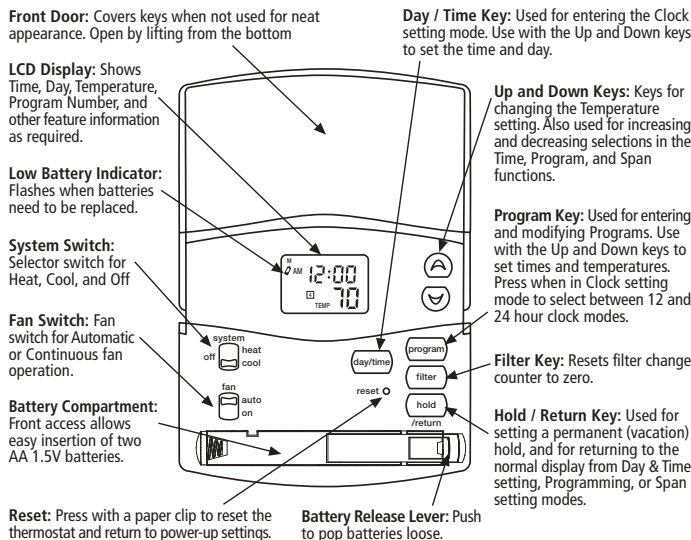

ENERGY STAR® PARTNER

As an ENERGY STAR® Partner, Hunter Fan Co. has determined that this programmable thermostat meets the ENERGY STAR® guidelines for energy efficiency.



INSTALLATION

What You Need

This thermostat includes two #8 slotted screws and two wall anchors for mounting. To install your thermostat, you should have the following tools and materials.

- Slotted Screwdriver(s)
- Small Philips screwdriver
- Hammer
- Electric drill and 3/16" bit
- Two 1.5 V (AA) size alkaline batteries

Remove Old Thermostat

CAUTION: Do not remove any wiring from existing thermostat before reading the instructions carefully. Wires must be labeled prior to removal.

- **IMPORTANT!** Turn off the power to the furnace at the main power panel or at the furnace.
- Remove existing thermostat cover and thermostat. See Figure 1. Some thermostats will have screws or other locking devices that must first be removed. Once the wall mounting plate is exposed, look for wires.

If wires are not visible, they may be connected to the back of the wallplate. Again, look for screws, tabs, etc. Some models have doors that open to expose wires and mounting screws. See Figure 1.

Typical Home Thermostats

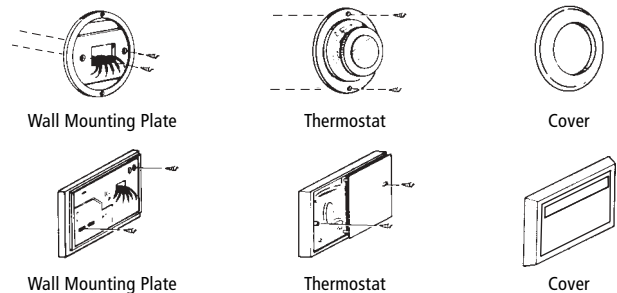

Figure 1

Wire Labeling

- Each wire coming from the wall to the existing thermostat is connected to a terminal point on that thermostat. Each of these terminal points is usually marked with a code letter as shown in Table A below.
- The number of wires in your system can be as few as two (for heat only systems), as many as eight, or any number in between. If you follow the labeling procedures correctly, you do not have to be concerned about how many wires there are.

- There is often no terminal marking on the existing thermostat of two wire, heat only systems. Just connect either of the wires to the RH terminal, then connect the other wire to the W terminal to complete the circuit.

- **IMPORTANT! BEFORE DISCONNECTING ANY WIRES, APPLY THE SELF-ADHESIVE LABELS PROVIDED TO THE WIRE AS SHOWN IN TABLE A BELOW.** (For example, attach the label marked W to the wire that goes to the W or H terminal on your existing thermostat.) **IGNORE THE COLOR OF THE WIRES** since these do not always comply with the standard.

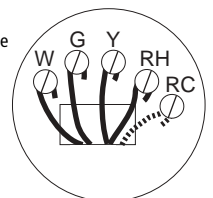

(Continued)

Wire Labeling (Continued)

- After labeling wires, disconnect them from the existing thermostat terminals.
- Remove existing wallplate. To make sure wires do not fall back into wall opening, you may want to tape them to the wall.
- If hole in wall is larger than necessary for wires, seal this hole with insulating material so that no hot or cold air can enter the back of the thermostat from the wall. This air could cause a false thermostat reading.

| If the code letter on your existing thermostat is | then mark the wire with label shown | and connect to thermostat terminal shown |
|---|-------------------------------------|--|
| RH, R, VR or 4 24 Volt | | |
| RC, VC 24 Volt Cool | | |
| G or F Fan | | |
| Y, C or M Air Conditioning Compressor | | |
| W or H Heating | | |

Table A

NOTE: Do not connect a "Common" wire (sometimes labeled "C") to any terminal on this thermostat. Tape up the wire and do not use. This wire provides electricity to non-battery powered thermostats.

Mount Wallplate and Thermostat

- Remove the wallplate from your thermostat by pressing the release tab on the bottom of the thermostat. See Figure 2.

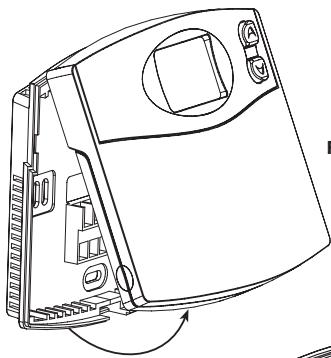

Figure 2

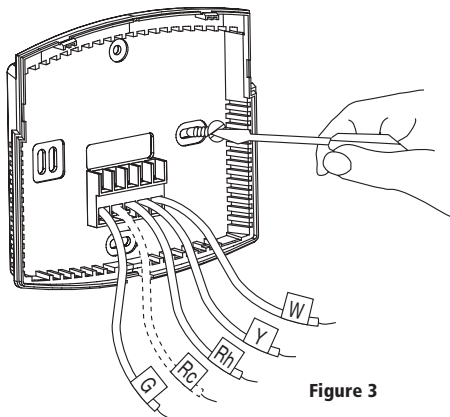

Figure 3

- Position wallplate on wall and pull existing wires through large opening. Then level for appearance. Mark holes for plastic anchors provided, if your existing holes do not line up with those on the Hunter wallplate.
- Drill holes with 3/16" bit and gently tap anchors into the holes until flush with wall.
- Reposition wallplate to wall, pulling wires through large opening. Insert mounting screws provided into wall anchor and tighten. See Figure 3.

NOTE: 5-wire Systems

If your thermostat has one wire marked R or RH (2, 3, or 4-wire system), then leave the jumper wire between the RH and RC terminals on the wallplate. Otherwise, if you have separate RH and RC wires (5-wire system), then remove the jumper wire between the RH and RC terminals.

Connect Wires and Mount Thermostat to Wallplate

- Match and connect the labeled wires to the appropriate coded terminal screws on the wallplate. (See Figure 4, 5.) Ignore any wires which may be present, but which were not connected to the old thermostat.
- Refer to the Wiring Diagrams below to be sure your system is wired correctly.
- Be sure to tighten the terminal screws securely, otherwise a loose wire could cause operational problems with your system or thermostat.
- Push excess wire back into the hole to prevent interference when installing the thermostat to the wallplate.
- Make sure the System Switch is set to OFF, and the Fan Switch is set to AUTO.
- Insert the bottom tab on the thermostat body into the slot at the bottom of the wallplate. Press the top of the thermostat body to snap it into the wallplate. Refer to Figure 6. (**NOTE: Do not force the thermostat onto the wallplate, as the terminal pins may be damaged. If it does not snap properly, the thermostat may not work.**)
- Insert the two AA size alkaline batteries, observing the polarity marked inside the battery compartment.
- Switch on the main power at the panel or furnace.

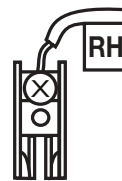

Figure 4

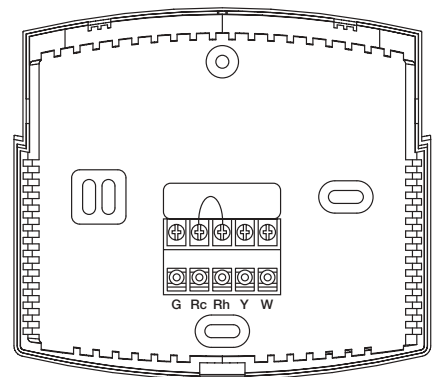

Figure 5

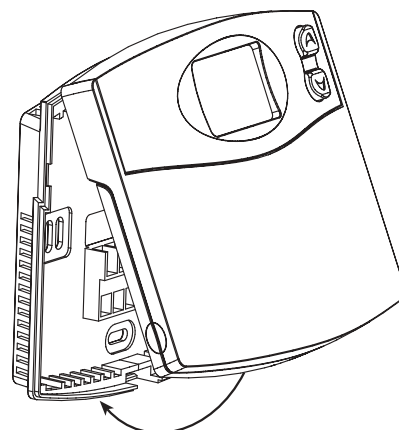
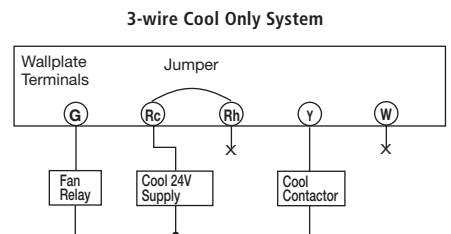
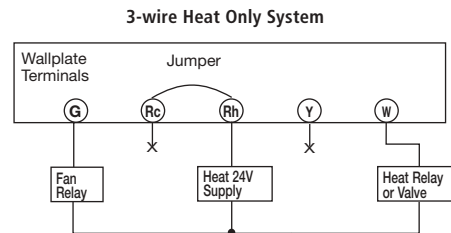
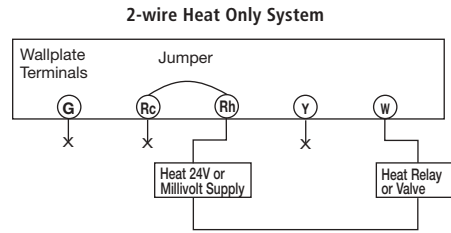
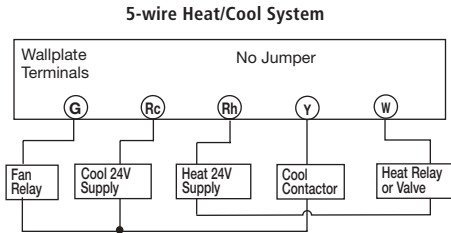
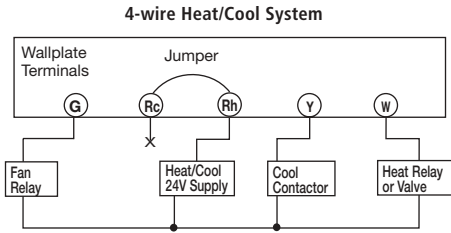

Figure 6

Wiring Diagrams



X - No Connection

Selector Switches

In order for this thermostat to control your system, the system type must be specified by the selector switches on the printed circuit board inside the thermostat.

■ **Heating System Selector (HG - HE switch)**

The factory position for this switch is in the "HG" position. Leave it in this position if you have a gas furnace or an oil burner. If you have an electric furnace, test to see whether the Heat and Fan come on as expected after installation. If the Fan operation is normal, leave it in the "HG" position. If the Fan does not come on within a minute of the thermostat calling for heat, change the switch position to "HE". The system selector has no effect in the cooling mode.

NOTE: "HG" position is for gas and most other systems. "HE" position is for certain electric systems having a fan relay.

■ **Auto Recovery selector (DISABLE/ENABLE)**

Your thermostat is set from the factory with the Auto Recovery Feature enabled, which complies with the EPA ENERGY STAR® Program. If you prefer to use normal recovery, slide the switch to the DISABLE position.

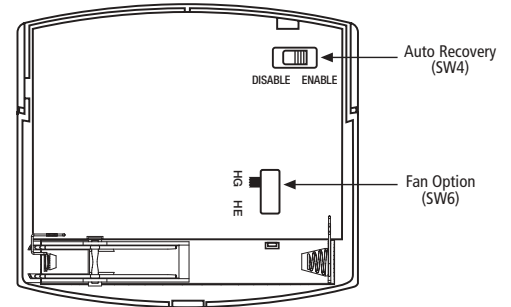

Figure 7

F° / C° Selection (Fahrenheit / Celcius)

Your thermostat is set for F° mode from the factory. To change to C° mode, follow these steps:

- Press and hold the Up key.
- Use a paper clip to press the reset key.
- Once all the LCD segments turn on, release the Up key.

NOTE: To return to F° mode, press the reset key with a paper clip. Do not press any other keys during the reset process.

All programs and settings will be lost when pressing RESET.

OPERATION

Setting Day and Time

- The LCD will show this information when batteries are first installed, or after the Reset button is pressed. The temperature will update after a few seconds.
- During time and day setting mode, the temperature and program displays will go blank.
- Example: Set the Thermostat to the current time of 2:16 pm on Saturday. Refer to the Steps below.

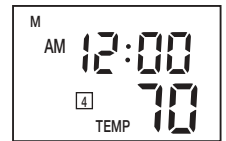

STEP 1:



- Press to enter time and day setting mode. The current hour and the AM / PM indicator will be flashing.



- Press to change the Hour up or down to the current hour. Note the AM / PM indicator, as the display will change at 12 AM and 12 PM.

STEP 2:



- Press again to change from hour setting to minute setting. The current minute will be flashing.



- Press to change the Minute up or down to the current minute.

(Continued)

Setting Day and Time (Continued)

STEP 3:

day/time

■ Press again to change from minute setting to day setting. The current day will be flashing.

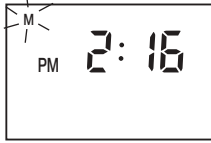

■ Press to change the Day up or down to the current day.

STEP 4:

day/time

■ Press again to change back to the normal display.

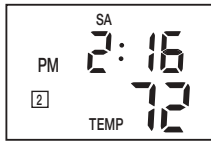

or
hold
/return

NOTE: You may press **hold** /return at any time during Day and Time setting to return to the normal display.

12 Hr. / 24 Hr. Time Format

Your thermostat is set from the factory in normal 12 (AM / PM) time format. To change to 24 hour (military) time, press **program** at any time while the Hour, Minute, or Day is flashing to toggle between the 12 hour and 24 hour formats. The AM / PM indicator will not be displayed in 24 hour mode. Both the current time and all programs will automatically change to the selected format.

PROGRAMMING

The following time and temperature settings are pre-programmed into the thermostat:

| Program Number | Time | Temperature in C° (F°) | |
|----------------|----------|------------------------|-------------|
| | | Heat | Cool |
| 1 | 6:00 am | 68°F (20°C) | 78°F (26°C) |
| 2 | 8:00 am | 60°F (16°C) | 85°F (29°C) |
| 3 | 4:00 pm | 68°F (20°C) | 78°F (26°C) |
| 4 | 10:00 pm | 60°F (16°C) | 82°F (28°C) |

■ All 7 days of the week have the same default programs.

Personal Program Schedule

■ You can revise the factory programs to match your own schedule. Use this Personal Program Schedule to determine which times and temperature settings match your comfort and energy saving requirements. Use a pencil so you can revise your records each time you change your program settings.

Heating

| Day | Program 1 | Program 2 | Program 3 | Program 4 |
|-------------------|--------------|--------------|--------------|--------------|
| Monday – Friday | Time Temp | Time Temp | Time Temp | Time Temp |
| Saturday – Sunday | Time Temp | Time Temp | Time Temp | Time Temp |

Cooling

| Day | Program 1 | Program 2 | Program 3 | Program 4 |
|-------------------|--------------|--------------|--------------|--------------|
| Monday – Friday | Time Temp | Time Temp | Time Temp | Time Temp |
| Saturday – Sunday | Time Temp | Time Temp | Time Temp | Time Temp |

Revising Programs

■ Familiarize yourself with manually changing programs, so that you can easily modify the programs as your comfort needs change. Follow the steps below to change the program times and temperatures.

- NOTE: 1) The program time can be set in 10-minute increments.
2) The program temperature can be set in increments of 1°F (1°C).
3) After 15 seconds without a key press, the thermostat will return to normal display mode.
4) When setting the program time, note the AM / PM indicator.

STEP 1:

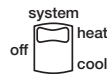

■ Slide the System Switch to the HEAT or COOL position to program the corresponding system.

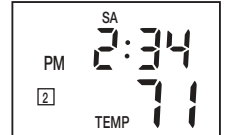

NOTE: If the System Switch is in the OFF position, the last position used will be programmed.

STEP 2:

program

■ Press to enter program mode. HEAT or COOL will be displayed on the LCD.

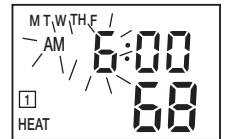

STEP 3:



■ The Program hour and AM or PM indicator are flashing. Press to change the hour.

STEP 4:

program

■ Press again to change to the minute position. The current minute will be flashing.

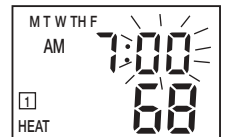

■ Press to change the minute.

STEP 5:

program

■ Press again to change to the program temperature. The current temperature will be flashing.

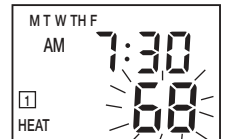

■ Press to change the temperature.

STEP 6:

program

■ Press again to move to the next program number.

■ Repeat Steps 3 through 5 to change the remaining Weekday and Weekend programs. (There are a total of 8 programs.)

program

■ After cycling through all 8 programs, press again to return the display to normal.

hold
/return

■ Press at any time to exit the Program Mode.

Reviewing Programs

To review your program settings, press **program** repeatedly to cycle through the programs. You can also make changes at any time.

System Selector Switch

The System Selector switch on the front of the thermostat determines the operating mode of the thermostat. You may select COOL, OFF, HEAT.

NOTE: Anytime you install or remove the thermostat from the wallplate, slide the System Selector to the OFF position to prevent the possibility of a rapid system On-Off.

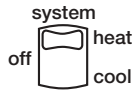

Fan Switch

The Fan switch should normally be located in the AUTO position. The Fan will be turned on along with normal operation of your system. In a normal gas or oil furnace, the Fan will be turned on by your furnace after its warm-up delay. For electric heat, air conditioning, and heat pump operation, the Fan will turn on with the system.



To run the Fan on continuously, slide the Fan switch to the ON position.

Temporary Manual Override

To temporarily change the current set temperature without affecting your program:



■ Press and hold for about 1 second to enter Manual Override mode. When display flashes, you can release the key.

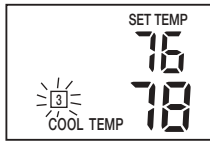

■ Press again to change to your desired Set Temperature. Hold the key for 2 seconds to fast-advance the Set Temperature.



■ Press to return to normal mode, or wait 5 seconds for it to return automatically.

■ The current program number will flash to signify the Temporary Override.

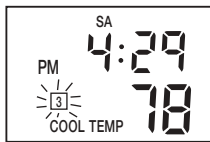

■ At the next program change time, the Temporary Override is cancelled, and the next program temperature becomes the setpoint temperature.

To end the Temporary Manual Override:



■ Press, then press again. This will return the set temperature to the current program set temperature.

Permanent Override

To hold your Manual Override for vacation or just an extended period of time:



■ Press to make the current program temperature the HOLD temperature. HOLD will be displayed on the LCD, and the Program number will disappear.

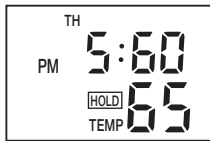

■ Follow the Temporary Manual Override instructions above to change the Permanent Manual Override temperature.



■ You can confirm the held set temperature by pressing for less than 1 second.

To end the Permanent Manual Override:



■ Press again. The thermostat will return to the current program, and the HOLD display will be canceled.

Filter Change Indicator

Your thermostat measures the number of hours your heating and cooling system has been in use. To maximize your system's performance and energy efficiency, change or clean your filter regularly.



■ When the total system runtime for heat and cool reaches 400 hours, the Filter Change Indicator will flash as a reminder to check your system's filter.

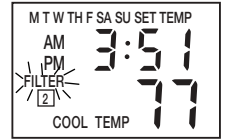

■ After changing or cleaning the system's filter, press and hold the Filter Key for 3 seconds. The display will blink, and the timer will be reset to zero.

Note: Pressing the Filter Key at any time for less than 3 seconds will cause the Filter indicator to appear on the LCD. This is only to confirm key operation, and the timer is not affected unless the key is held for greater than 3 seconds.

SPAN Setting Mode

Your thermostat is set at the factory to cycle at 1°F (0.5°C) above and below the set temperature. (Span = 2) This setting has been designed to provide a comfortable room temperature under most all conditions. However, if you find your system cycling too fast or too slow, then the Span can be adjusted to modify the cycle time.



■ Press and hold BOTH for three seconds. The display will flash, and SPAN will be displayed on the LCD.



■ Press to raise the Span to 3. This setting INCREASES the cycle time by allowing your system to run LONGER.



■ Press to lower the Span to 1. This setting DECREASES the cycle time by causing your system to run SHORTER.

The Span settings remain the same for both HEAT and COOL.

The Span can be changed at any time, and is independent of program times or temperatures.

When batteries are installed in the thermostat, or the Reset key is pressed, the Span is reset back to setting 2.

Low Battery Warning

Your thermostat has a two-stage low battery warning system. When the batteries are first detected to be weak, the first stage low battery warning is indicated by battery symbol flashing on the LCD display. At your earliest convenience, you need to replace the batteries with 2 new AA alkaline batteries.

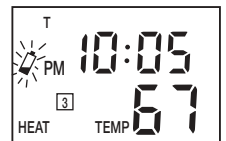

When the batteries become too weak for normal operation, the thermostat enters the second stage low battery warning which shuts down the thermostat. In this condition, "BATT" flashes alone on the display, and the thermostat will turn your system Off. Your system will remain shut-off until the batteries are replaced.

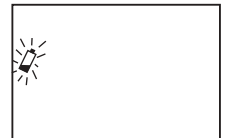

Note: The thermostat will still keep the current time and your programs in memory until new batteries are installed. After confirming that new batteries have been inserted, the thermostat will return to normal operation.

Auto Recovery

Hunter's Auto Recovery feature meets the ENERGY STAR® guidelines for energy efficiency by allowing the heating or cooling system to recover gradually from an energy-saving setpoint temperature to a comfort setpoint temperature.

Auto Recovery calculates how early to turn your system back On, so that the room temperature is already comfortable by the start of the comfort temperature program period. Auto Recovery works in both Heat and Cool modes.

- When the thermostat is in Auto Recovery mode, the display will alternate "RECO" with time, and the program indicator will flash.
- Auto Recovery can be disabled by sliding the Recovery switch on the circuit board to disable.
- Auto Recovery will not operate if Permanent hold or Temporary hold is in operation.
- Auto Recovery can be canceled manually if HOLD / RETURN is pressed during the recovery process.
- Auto Recovery will be canceled and change to Temporary Manual Override mode if the setpoint is adjusted during the recovery process.

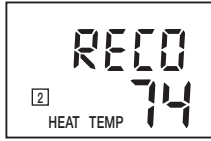

Error Mode

If the thermostat is unable to control your system due to an unexpected battery problem, the thermostat will enter Error Mode. In this condition, the thermostat flashes "Err" on the LCD display, and shuts off your system. To correct this problem, replace the batteries with 2 new AA alkaline batteries, even if you have recently replaced them. Next, use a paper clip to press the RESET button next to the keypad. You will need to reprogram your thermostat and confirm normal operation.

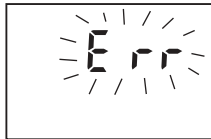

If Error Mode returns, please call Hunter Technical support at 1-888-830-1326 for further information.

Auto Cut Off

Your thermostat will automatically cut-off in Heat mode if the room temperature rises above 95°F (35°C). It will cut-off in Cool mode if the room temperature drops below 40°F (4°C).

Note that if your system has malfunctioned and no longer responds to thermostat controls, the Auto Cut-Off will have no effect.

TROUBLESHOOTING

| Problem | Solution |
|--|--|
| No Display | <ol style="list-style-type: none"> 1. Check battery connections and batteries. 2. Press RESET button with a small pin and hold in for two seconds. |
| Entire Display Dims | <ol style="list-style-type: none"> 1. Replace Batteries |
| Program Does Not Change at your Desired Setting | <ol style="list-style-type: none"> 1. Check that the time is set properly to "AM" or "PM". 2. Check that the thermostat is not in Permanent HOLD mode. 3. Check for the correct day setting. |
| Auto Fan Does Not Turn On Properly | <ol style="list-style-type: none"> 1. Move HG/HE selector to correct position. |
| Heating or Cooling Does Not Go On or Off | <ol style="list-style-type: none"> 1. Check that the function switch is in the correct position ("HEAT" or "COOL"). 2. There may be as much as 4-minute delay before the system turns On - wait and check. (Compressor protection delay.) 3. Check your circuit breakers and switches to ensure there is power to the system. 4. Replace batteries. 5. Make sure your furnace blower door is closed properly. 6. If your system only uses 4-wires, be sure the jumper wire is installed between the RC and RH terminals. |
| Erratic Display | <ol style="list-style-type: none"> 1. Press the reset button once with a small pin and hold for two seconds. Then reprogram. |
| If unit continues to operate in the Off position | <ol style="list-style-type: none"> 1. Replace unit. |
| Thermostat permanently reads "HI", "LO", or "ERR" | <ol style="list-style-type: none"> 1. Replace unit. |

If you experience any other problems, call 1-888-830-1326 from 8 AM to 5 PM Central Time for technical assistance.